

**FLOOR AREA REQUIRED:**

1375 SF

**SCALE:** 1/8" = 1'-0"

**FUNCTION:**

**TYPICAL CRITICAL ADJACENCIES:**

**ELECTRICAL / COMMUNICATIONS:**

**TYPICAL EQUIPMENT REQUIREMENTS:**

**MECHANICAL / PLUMBING:**

**OTHER REQUIREMENTS:**

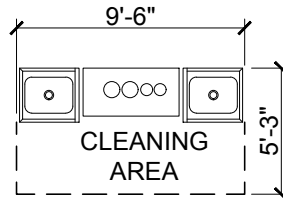

**FLOOR AREA REQUIRED:**

48 SF

**SCALE:** 1/8" = 1'-0"

**FUNCTION:**

**TYPICAL CRITICAL ADJACENCIES:**

**ELECTRICAL / COMMUNICATIONS:**

**TYPICAL EQUIPMENT REQUIREMENTS:**

**MECHANICAL / PLUMBING:**

**OTHER REQUIREMENTS:**

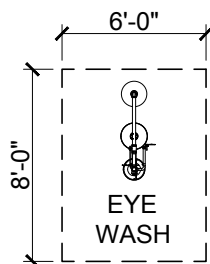

**FLOOR AREA REQUIRED:**

48 SF

**SCALE:** 1/8" = 1'-0"

**FUNCTION:**

**TYPICAL CRITICAL ADJACENCIES:**

**ELECTRICAL / COMMUNICATIONS:**

**TYPICAL EQUIPMENT REQUIREMENTS:**

**MECHANICAL / PLUMBING:**

**OTHER REQUIREMENTS:**

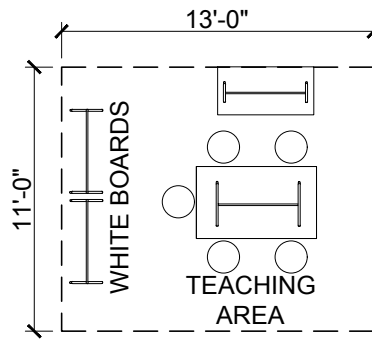

**FLOOR AREA REQUIRED:**

143 SF

**SCALE:** 1/8" = 1'-0"

**FUNCTION:**

**TYPICAL CRITICAL ADJACENCIES:**

**ELECTRICAL / COMMUNICATIONS:**

**TYPICAL EQUIPMENT REQUIREMENTS:**

**MECHANICAL / PLUMBING:**

**OTHER REQUIREMENTS:**

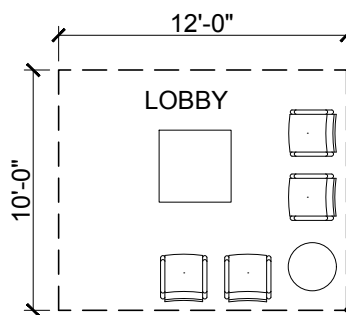

**FLOOR AREA REQUIRED:**

120 SF

**SCALE:** 1/8" = 1'-0"

**FUNCTION:**

**TYPICAL CRITICAL ADJACENCIES:**

**ELECTRICAL / COMMUNICATIONS:**

**TYPICAL EQUIPMENT REQUIREMENTS:**

**MECHANICAL / PLUMBING:**

**OTHER REQUIREMENTS:**

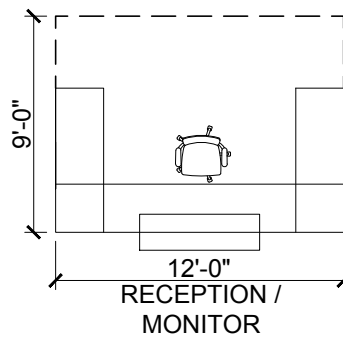

**FLOOR AREA REQUIRED:**

100 SF

**SCALE:** 1/8" = 1'-0"

**FUNCTION:**

**TYPICAL CRITICAL ADJACENCIES:**

**ELECTRICAL / COMMUNICATIONS:**

**TYPICAL EQUIPMENT REQUIREMENTS:**

**MECHANICAL / PLUMBING:**

**OTHER REQUIREMENTS:**

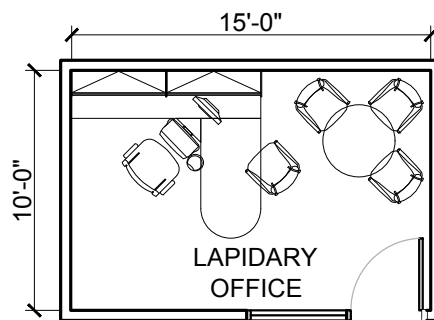

**FLOOR AREA REQUIRED:**

150 SF

**SCALE:** 1/8" = 1'-0"

**FUNCTION:**

**TYPICAL CRITICAL ADJACENCIES:**

**ELECTRICAL / COMMUNICATIONS:**

**TYPICAL EQUIPMENT REQUIREMENTS:**

**MECHANICAL / PLUMBING:**

**OTHER REQUIREMENTS:**

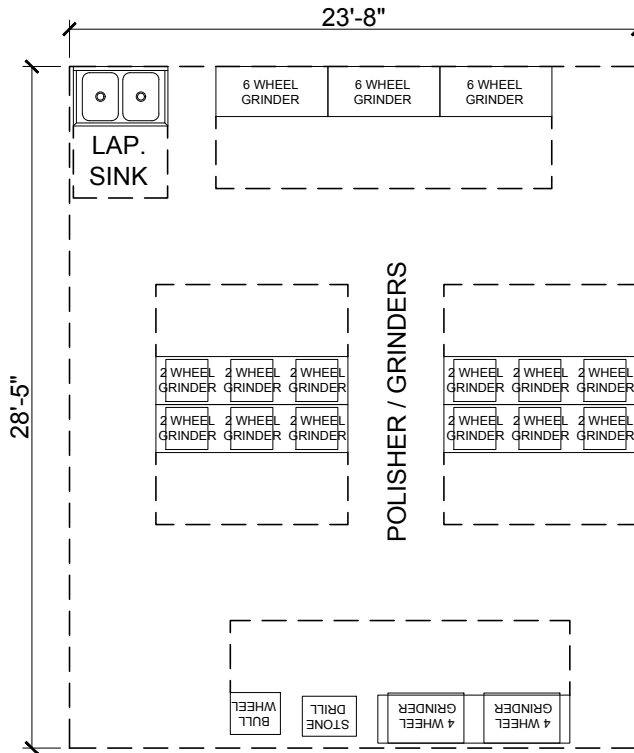

**FLOOR AREA REQUIRED:**

675 SF

**SCALE:** 1/8" = 1'-0"

**FUNCTION:**

**TYPICAL CRITICAL ADJACENCIES:**

**ELECTRICAL / COMMUNICATIONS:**

**TYPICAL EQUIPMENT REQUIREMENTS:**

**MECHANICAL / PLUMBING:**

**OTHER REQUIREMENTS:**



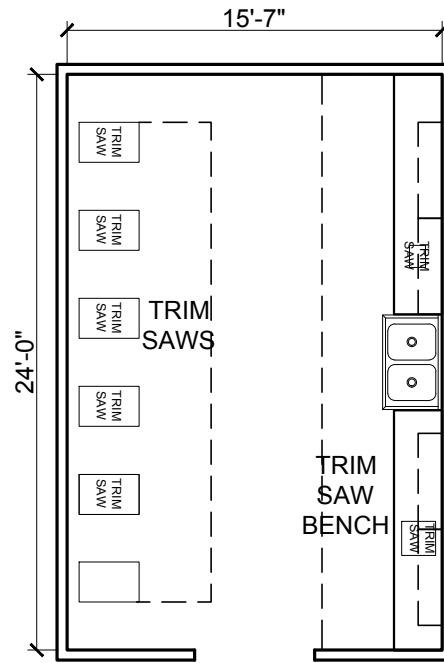

**FLOOR AREA REQUIRED:**

400 SF

**SCALE:** 1/8" = 1'-0"

**FUNCTION:**

**TYPICAL CRITICAL ADJACENCIES:**

**ELECTRICAL / COMMUNICATIONS:**

**TYPICAL EQUIPMENT REQUIREMENTS:**

**MECHANICAL / PLUMBING:**

**OTHER REQUIREMENTS:**

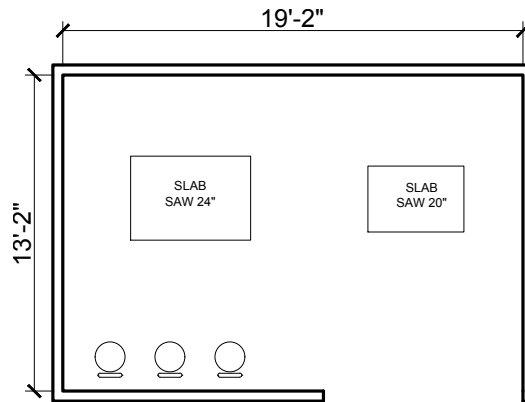

**FLOOR AREA REQUIRED:**

260 SF

**SCALE:** 1/8" = 1'-0"

**FUNCTION:**

**TYPICAL CRITICAL ADJACENCIES:**

**ELECTRICAL / COMMUNICATIONS:**

**TYPICAL EQUIPMENT REQUIREMENTS:**

**MECHANICAL / PLUMBING:**

**OTHER REQUIREMENTS:**

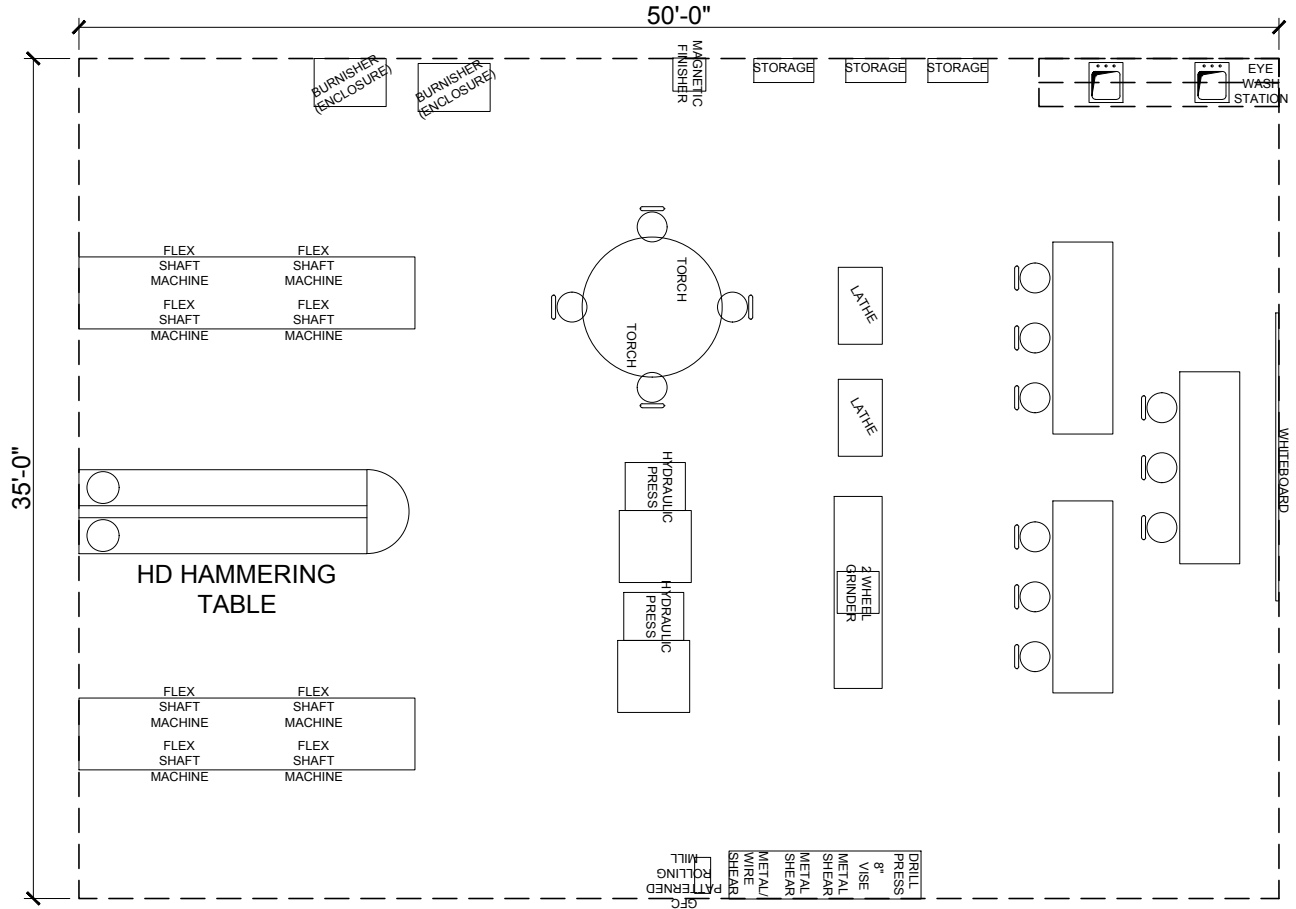

**FLOOR AREA REQUIRED:**

1750 SF

**SCALE:** 1/8" = 1'-0"

**FUNCTION:**

**TYPICAL CRITICAL ADJACENCIES:**

**ELECTRICAL / COMMUNICATIONS:**

**TYPICAL EQUIPMENT REQUIREMENTS:**

**MECHANICAL / PLUMBING:**

**OTHER REQUIREMENTS:**

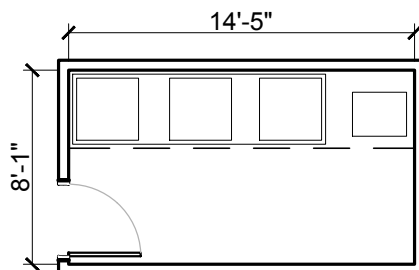

**FLOOR AREA REQUIRED:**

116 SF

**SCALE:** 1/8" = 1'-0"

**FUNCTION:**

**TYPICAL CRITICAL ADJACENCIES:**

**ELECTRICAL / COMMUNICATIONS:**

**TYPICAL EQUIPMENT REQUIREMENTS:**

**MECHANICAL / PLUMBING:**

**OTHER REQUIREMENTS:**

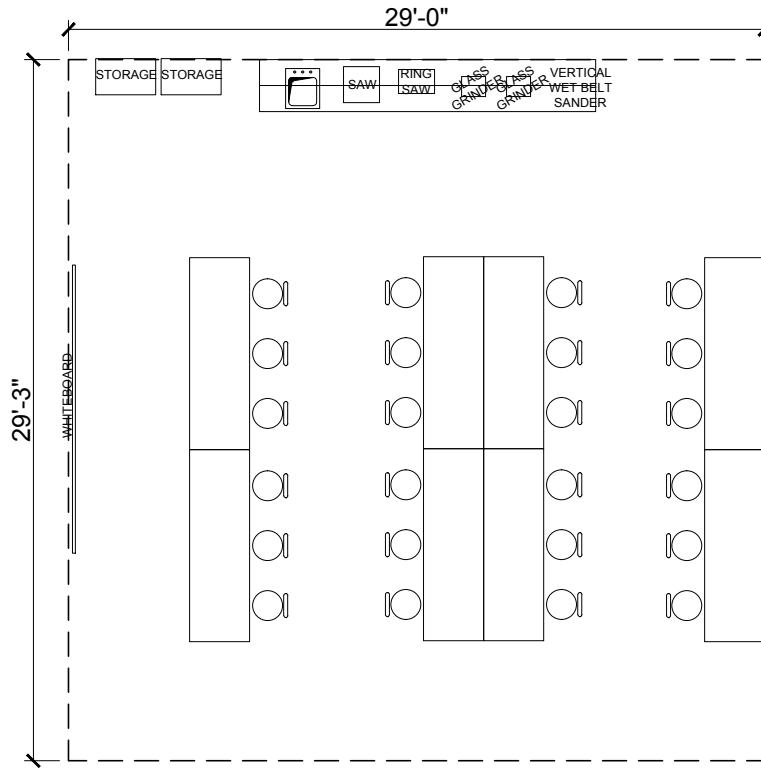

**FLOOR AREA REQUIRED:**

850 SF

**SCALE:** 1/8" = 1'-0"

**FUNCTION:**

**TYPICAL CRITICAL ADJACENCIES:**

**ELECTRICAL / COMMUNICATIONS:**

**TYPICAL EQUIPMENT REQUIREMENTS:**

**MECHANICAL / PLUMBING:**

**OTHER REQUIREMENTS:**

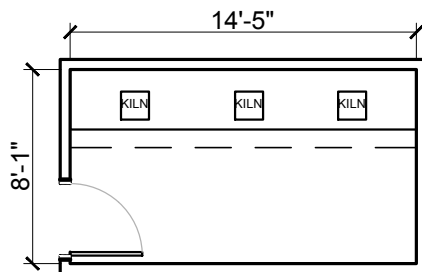

**FLOOR AREA REQUIRED:**

116 SF

**SCALE:** 1/8" = 1'-0"

**FUNCTION:**

**TYPICAL CRITICAL ADJACENCIES:**

**ELECTRICAL / COMMUNICATIONS:**

**TYPICAL EQUIPMENT REQUIREMENTS:**

**MECHANICAL / PLUMBING:**

**OTHER REQUIREMENTS:**

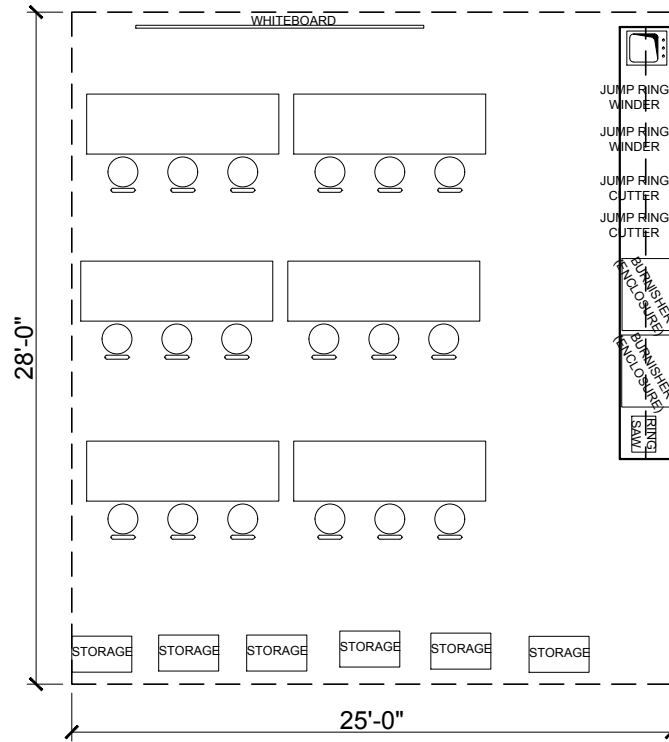

**FLOOR AREA REQUIRED:**

700 SF

**SCALE:** 1/8" = 1'-0"

**FUNCTION:**

**TYPICAL CRITICAL ADJACENCIES:**

**ELECTRICAL / COMMUNICATIONS:**

**TYPICAL EQUIPMENT REQUIREMENTS:**

**MECHANICAL / PLUMBING:**

**OTHER REQUIREMENTS:**

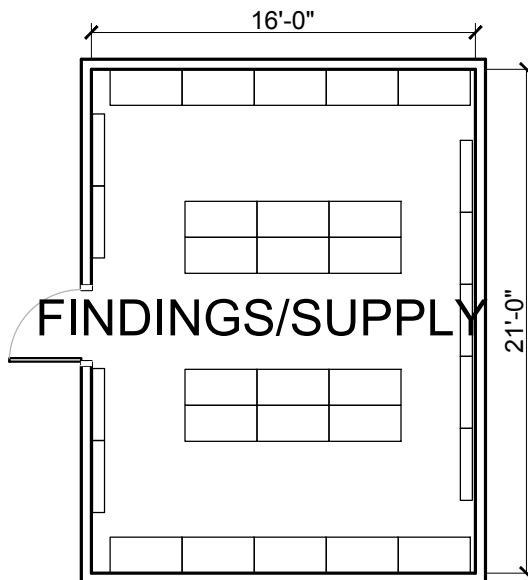

**FLOOR AREA REQUIRED:**

340 SF

**SCALE:** 1/8" = 1'-0"

**FUNCTION:**

**TYPICAL CRITICAL ADJACENCIES:**

**ELECTRICAL / COMMUNICATIONS:**

**TYPICAL EQUIPMENT REQUIREMENTS:**

**MECHANICAL / PLUMBING:**

**OTHER REQUIREMENTS:**



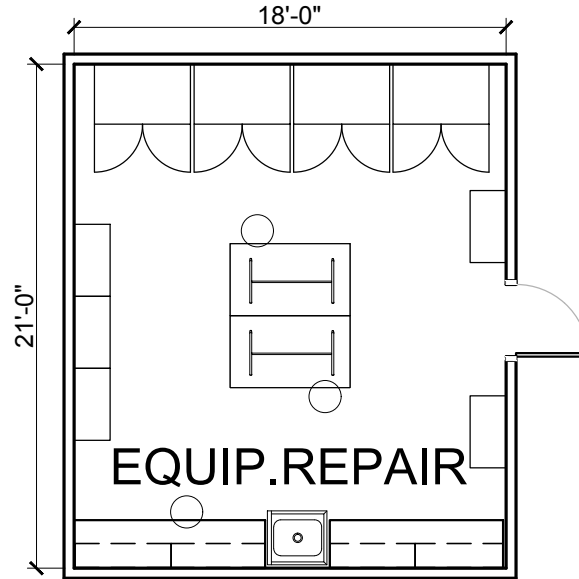

**FLOOR AREA REQUIRED:**

378 SF

**SCALE:** 1/8" = 1'-0"

**FUNCTION:**

**TYPICAL CRITICAL ADJACENCIES:**

**ELECTRICAL / COMMUNICATIONS:**

**TYPICAL EQUIPMENT REQUIREMENTS:**

**MECHANICAL / PLUMBING:**

**OTHER REQUIREMENTS:**

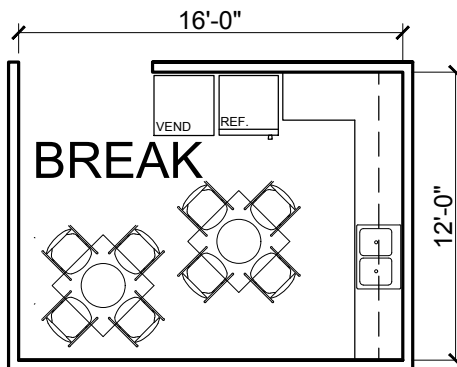

**FLOOR AREA REQUIRED:**

192 SF

**SCALE:** 1/8" = 1'-0"

**FUNCTION:**

**TYPICAL CRITICAL ADJACENCIES:**

**ELECTRICAL / COMMUNICATIONS:**

**TYPICAL EQUIPMENT REQUIREMENTS:**

**MECHANICAL / PLUMBING:**

**OTHER REQUIREMENTS:**

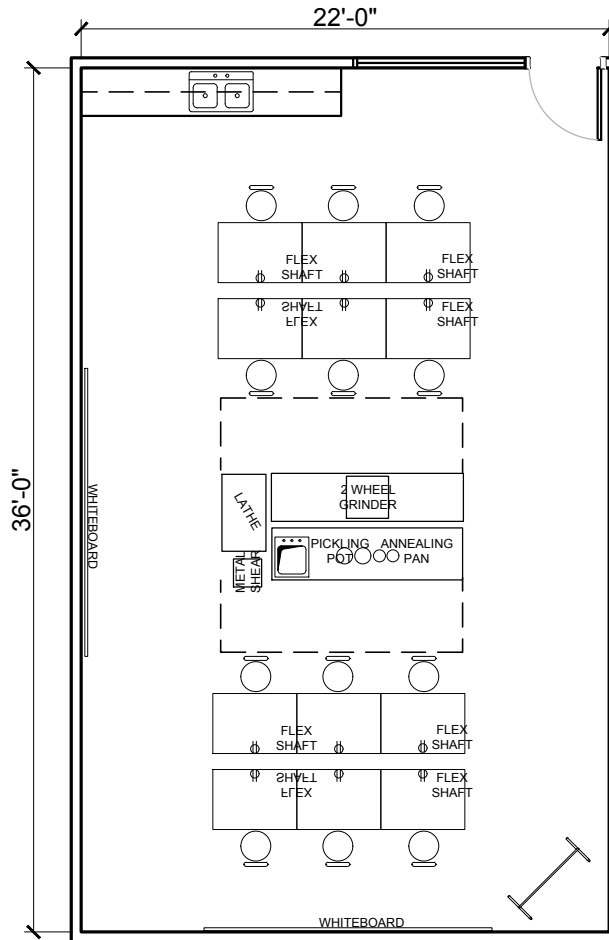

**FLOOR AREA REQUIRED:**

800 SF

**SCALE:** 1/8" = 1'-0"

**FUNCTION:**

**TYPICAL CRITICAL ADJACENCIES:**

**ELECTRICAL / COMMUNICATIONS:**

**TYPICAL EQUIPMENT REQUIREMENTS:**

**MECHANICAL / PLUMBING:**

**OTHER REQUIREMENTS:**

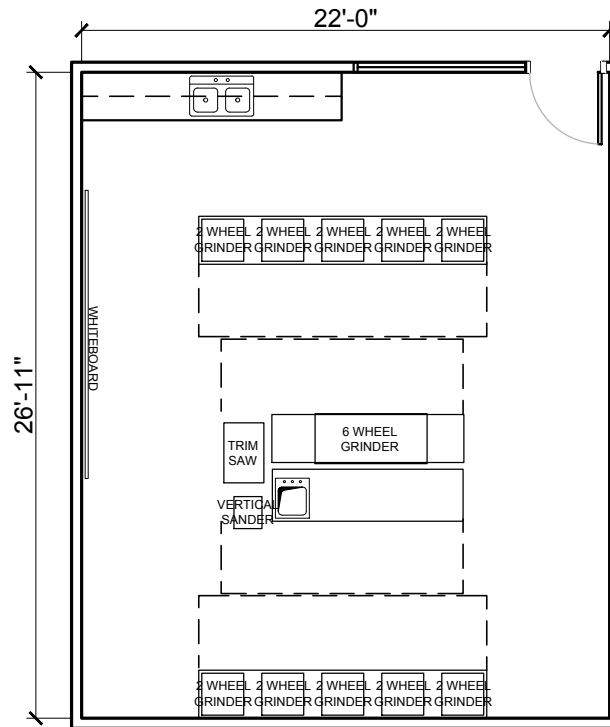

**FLOOR AREA REQUIRED:**

600 SF

**SCALE:** 1/8" = 1'-0"

**FUNCTION:**

**TYPICAL CRITICAL ADJACENCIES:**

**ELECTRICAL / COMMUNICATIONS:**

**TYPICAL EQUIPMENT REQUIREMENTS:**

**MECHANICAL / PLUMBING:**

**OTHER REQUIREMENTS:**

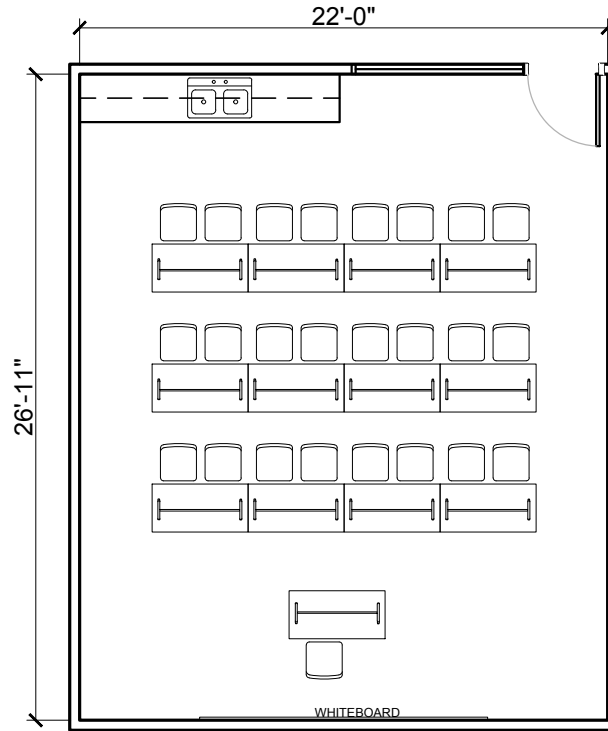

**FLOOR AREA REQUIRED:**

600 SF

**SCALE:** 1/8" = 1'-0"

**FUNCTION:**

**TYPICAL CRITICAL ADJACENCIES:**

**ELECTRICAL / COMMUNICATIONS:**

**TYPICAL EQUIPMENT REQUIREMENTS:**

**MECHANICAL / PLUMBING:**

**OTHER REQUIREMENTS:**